

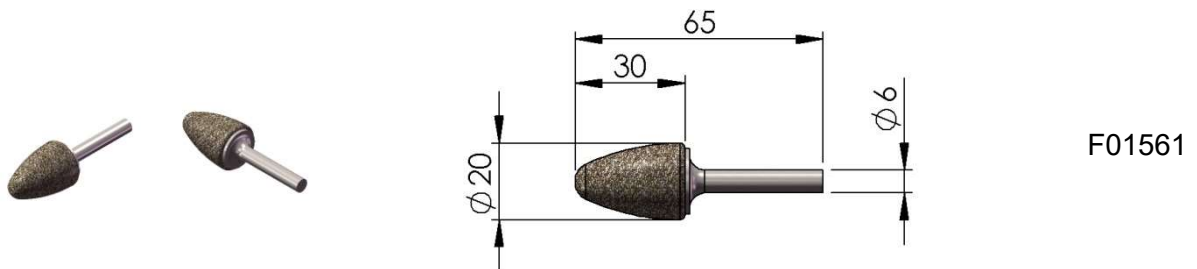

DIAMOND BURRS FOR CAST IRON GRINDING Ø6 MM SHANK CONNECTION

PAG 1 / 5

FEATURES : HIGH REMOVAL RATE - LONG LIFE
APPLICATIONS : CAST IRON (GREY AND NODULAR) - SOFT STONES - FRP - OTHER
MACHINES : DEVELOPED FOR HIGH FREQUENCY AND AIR GRINDERS
SPEED : SPEED IS NORMALLY 18.000 RPM BUT HIGHER IS ADVISABLE
SAFETY : MAX SPEED 60.000 RPM

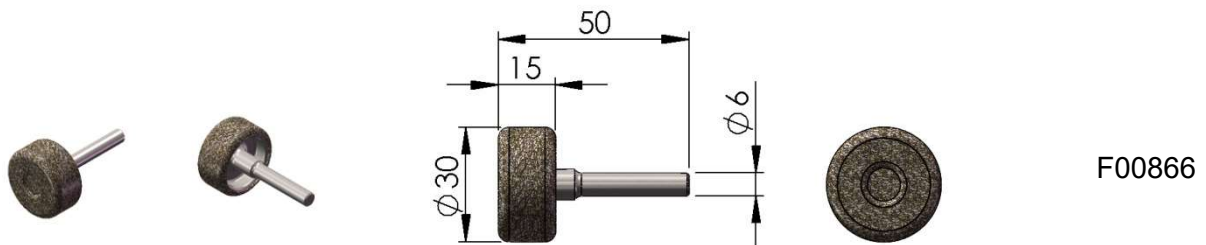
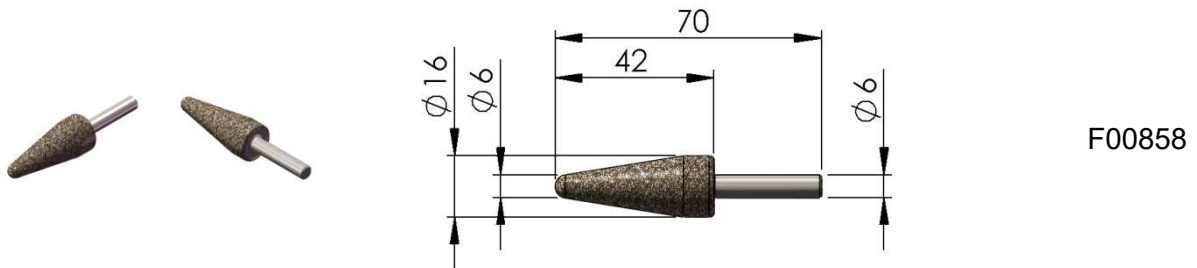
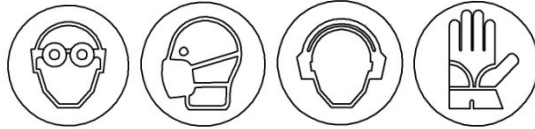

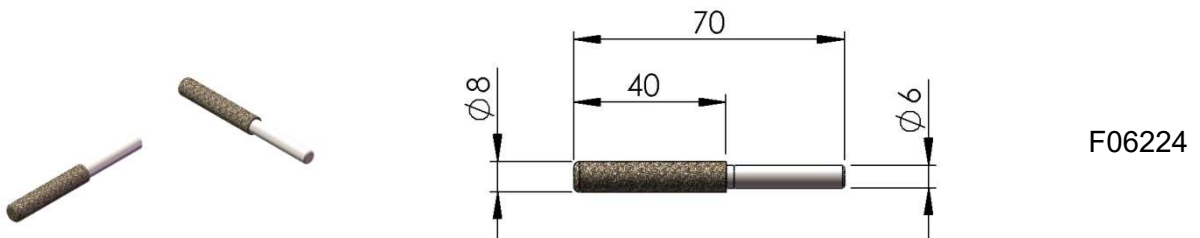
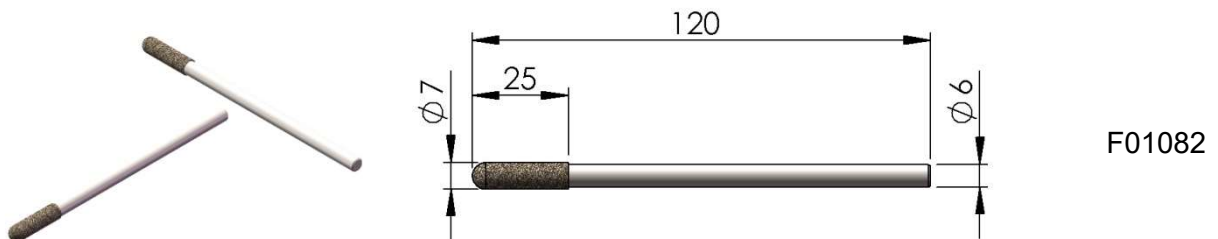
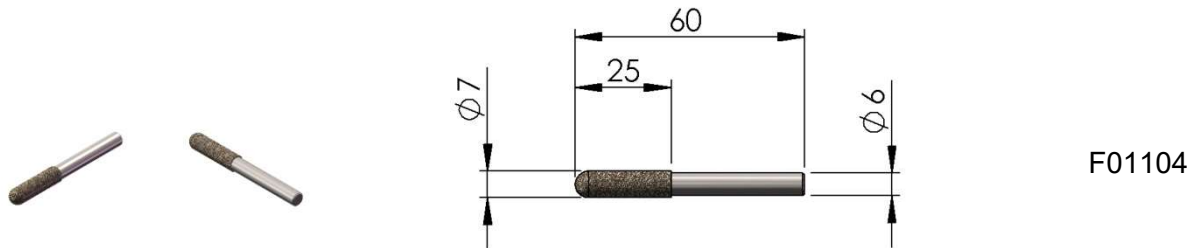
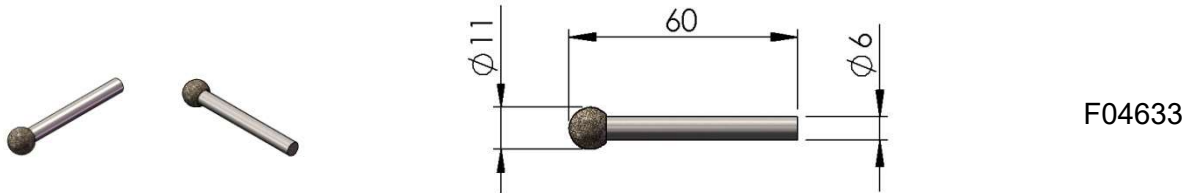

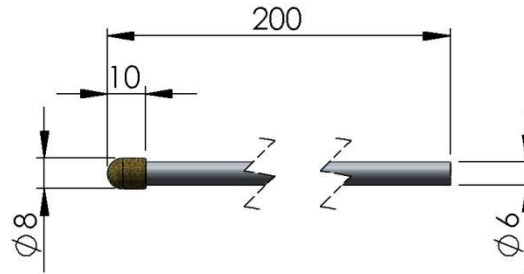
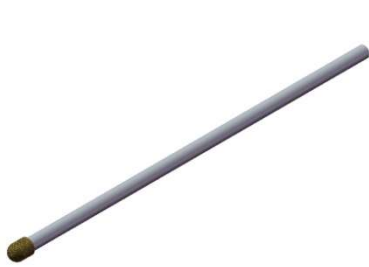

F05224

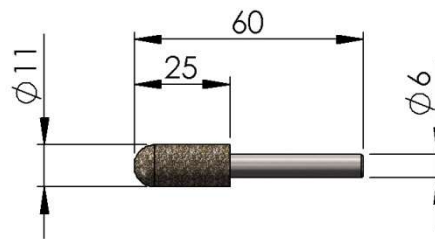

F01084

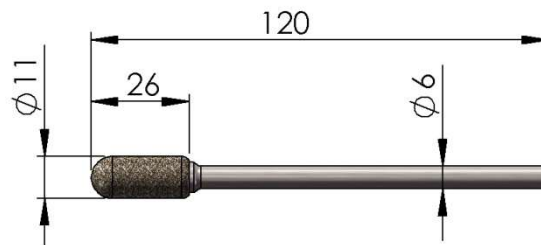

F01069

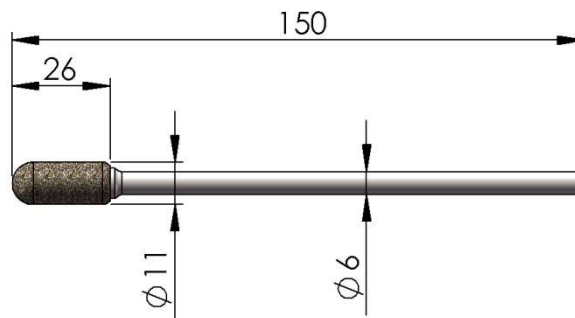

F05668

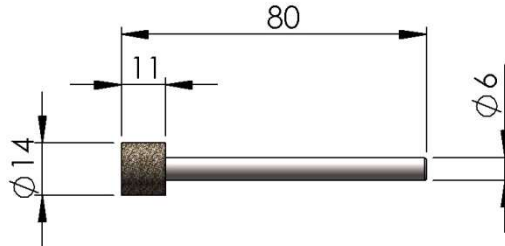
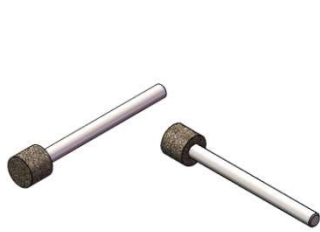

F05232

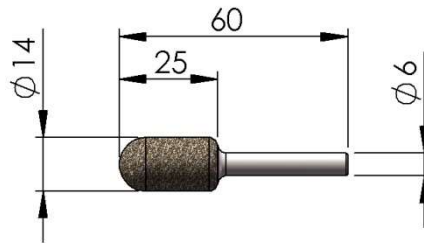

F01726

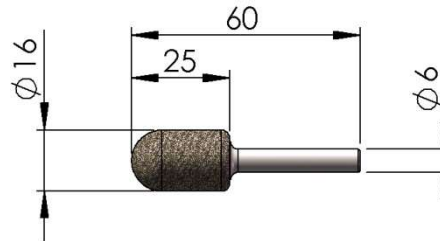

F01727

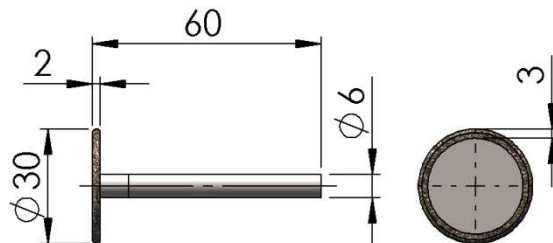

F05960

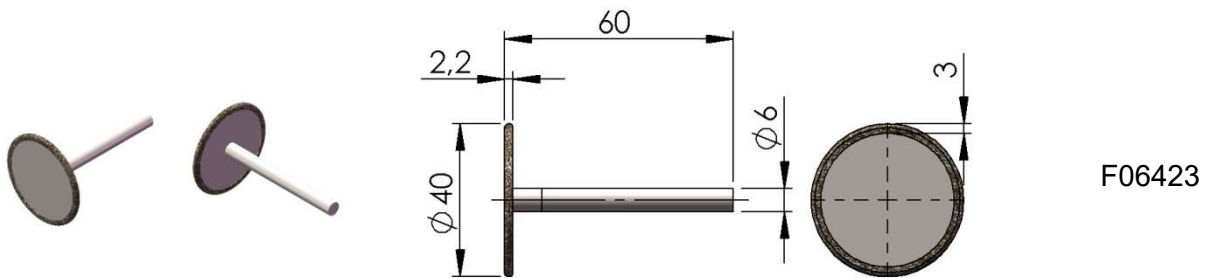

F06423

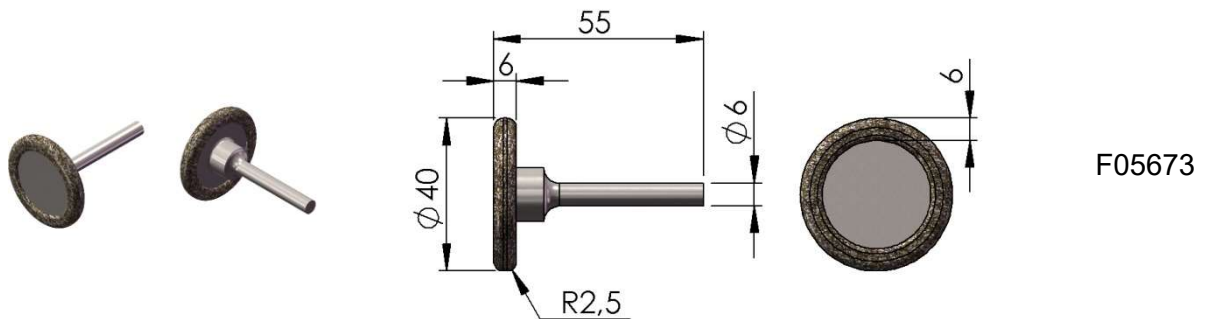

F05673

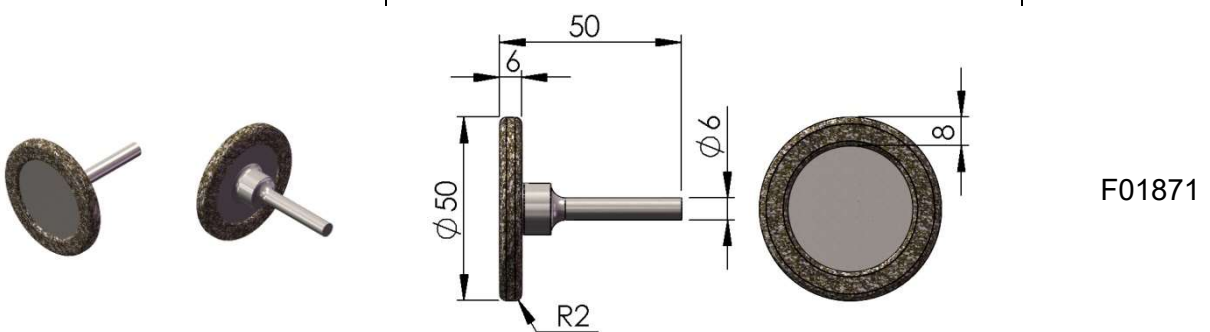

F01871