

FEATURES : HIGH REMOVAL RATE - LONG LIFE
 APPLICATIONS : CAST IRON (GREY AND NODULAR) - SOFT STONES - FRP - OTHER
 MACHINES : DEVELOPED FOR HIGH FREQUENCY AND AIR GRINDERS
 SPEED : SPEED IS NORMALLY 18.000 RPM BUT HIGHER IS ADVISABLE
 SAFETY : MAX SPEED 60.000 RPM

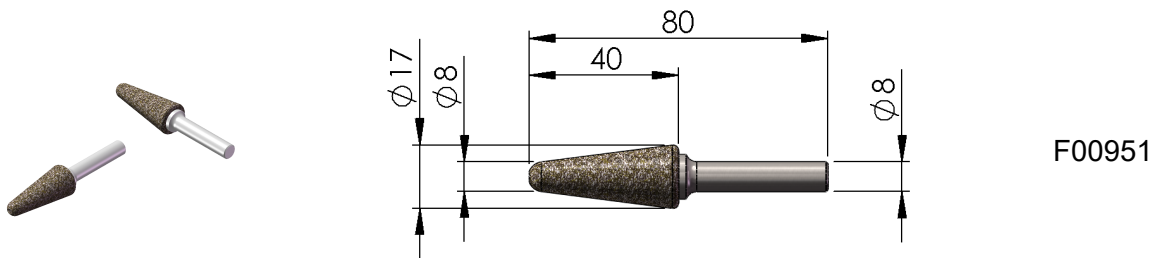

F00951

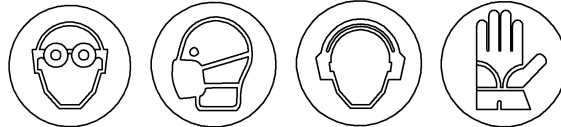
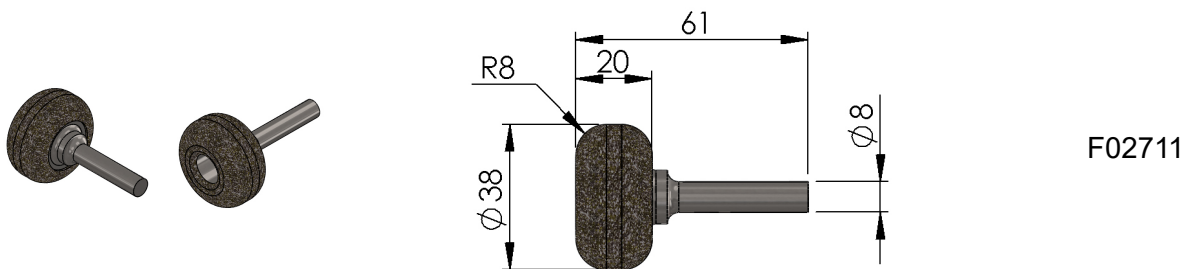

F02711

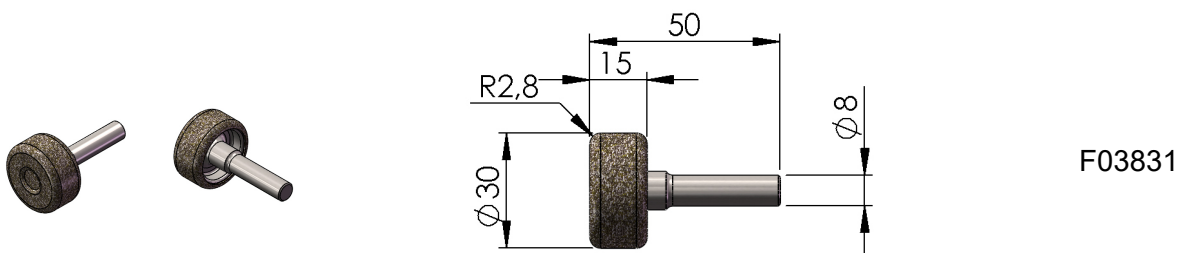

F03831

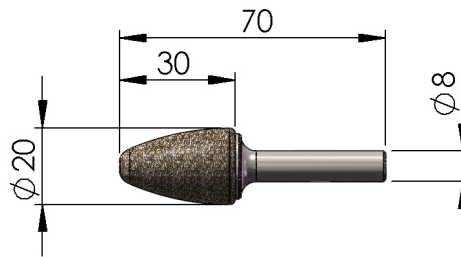

F01430

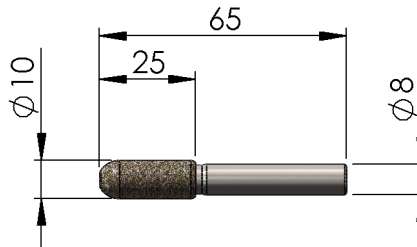

F00859

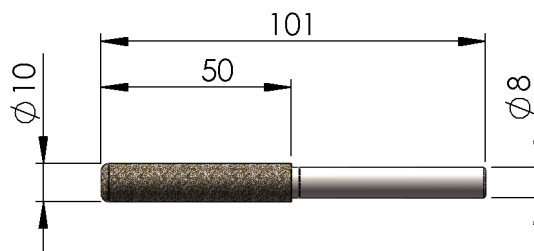
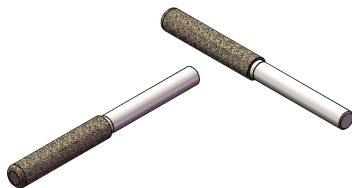

F02838

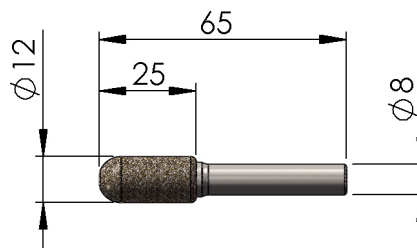
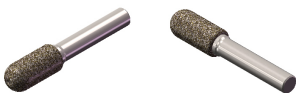

F00981

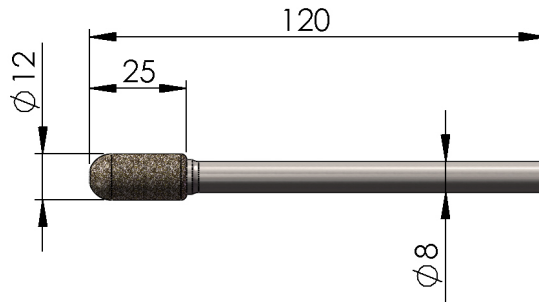

F05987

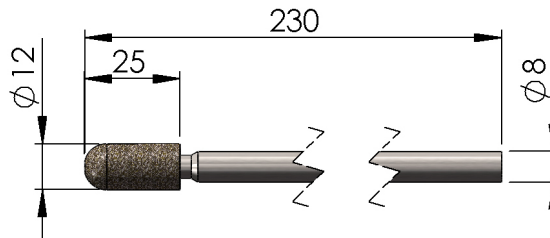
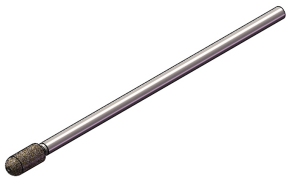

F06410

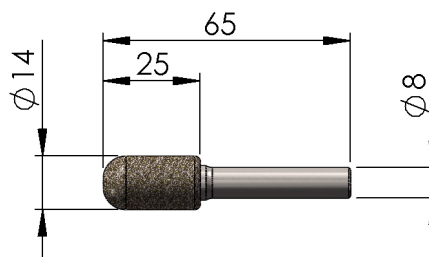
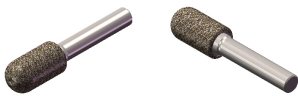

F00860

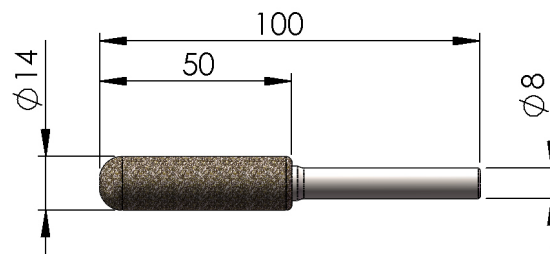
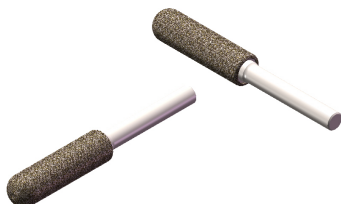

F06631

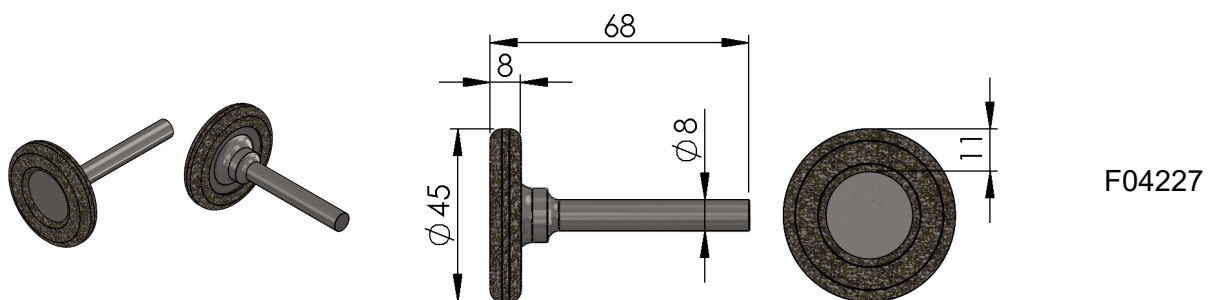
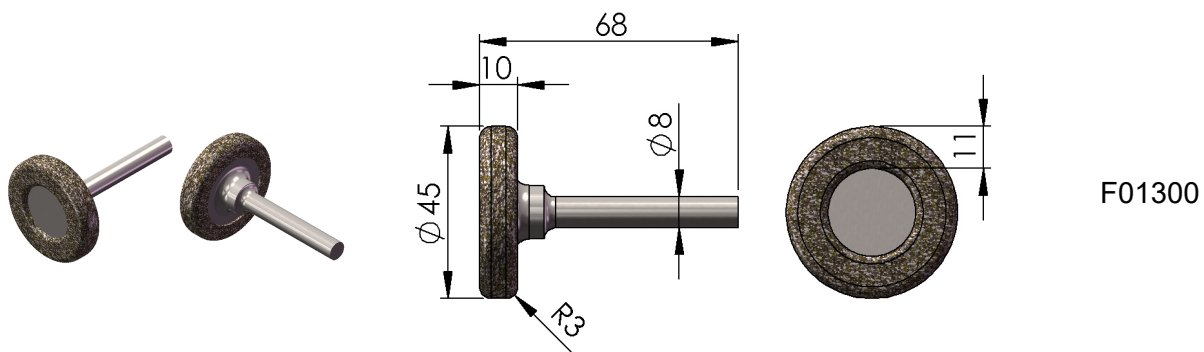
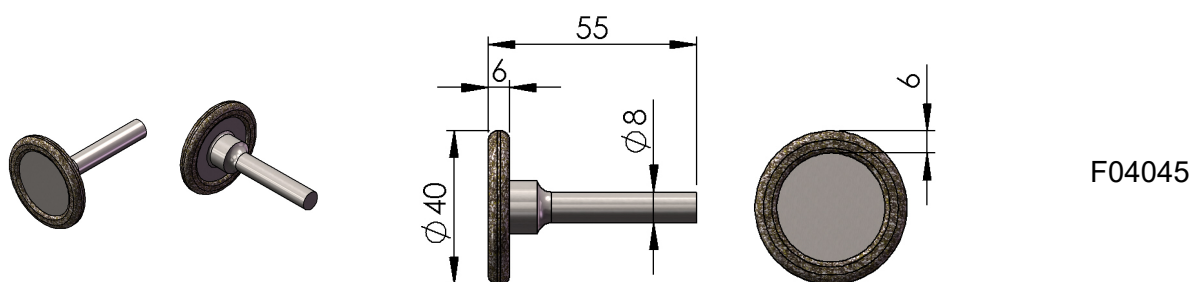
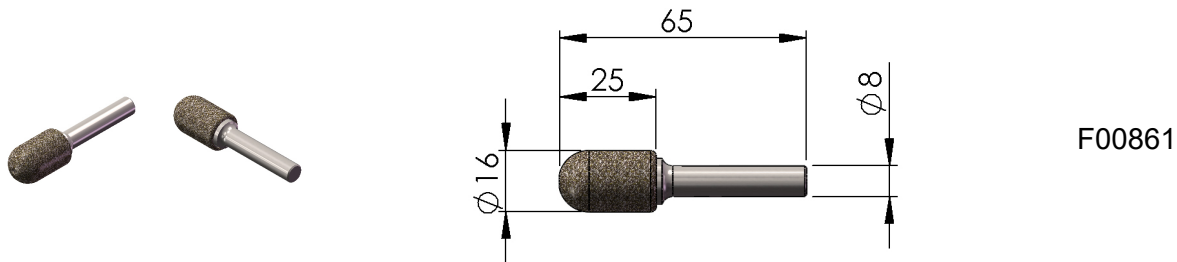

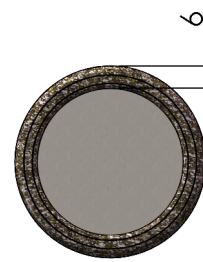
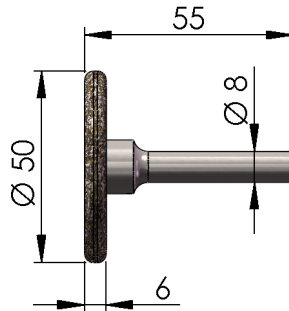
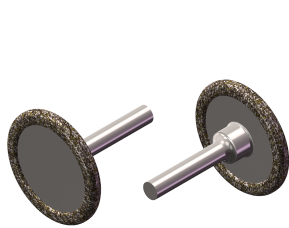

F04049

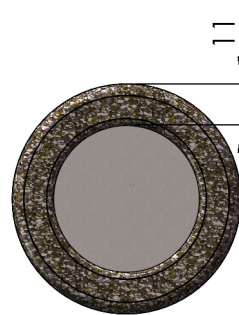
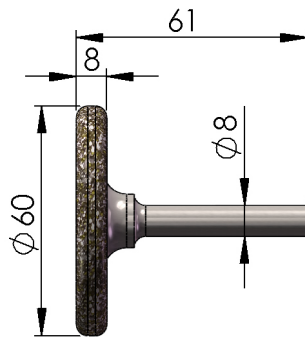
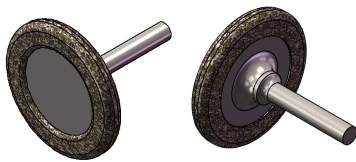

F03077