

HSK63A

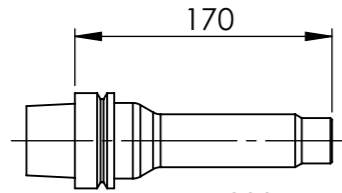

F07609.0 - Ø 45 X 20

HSK63A

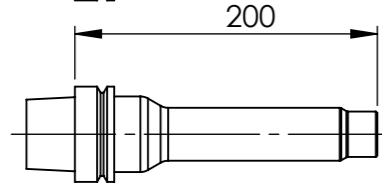

F01273.0 - Ø 50 X 12

HSK63A

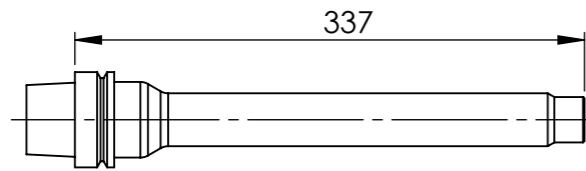

F07495.0 - Ø 50 X 20

Ø20 WELDON

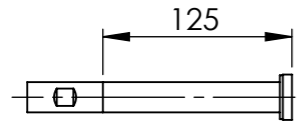

F00172.0 - Ø 60 X 12

Ø25 WELDON

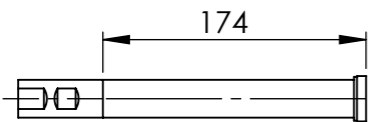

F01747.0 - Ø 70 X 20

Ø25 WHISTLE NOTCH (x 2)

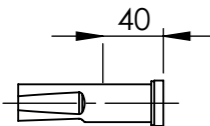

F04333.0 - Ø 80 X 20

Ø30 CYL.

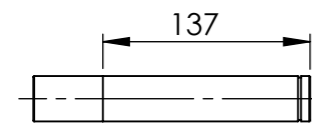

F04810.0 - Ø 90 X 20

Ø18/M12 (KOYAMA 400)

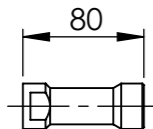

F03465.0 - Ø 100 X 20

Ø20/M16L (REICHMANN & KOYAMA 500)

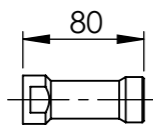

F00550.0 - Ø 130 X 8

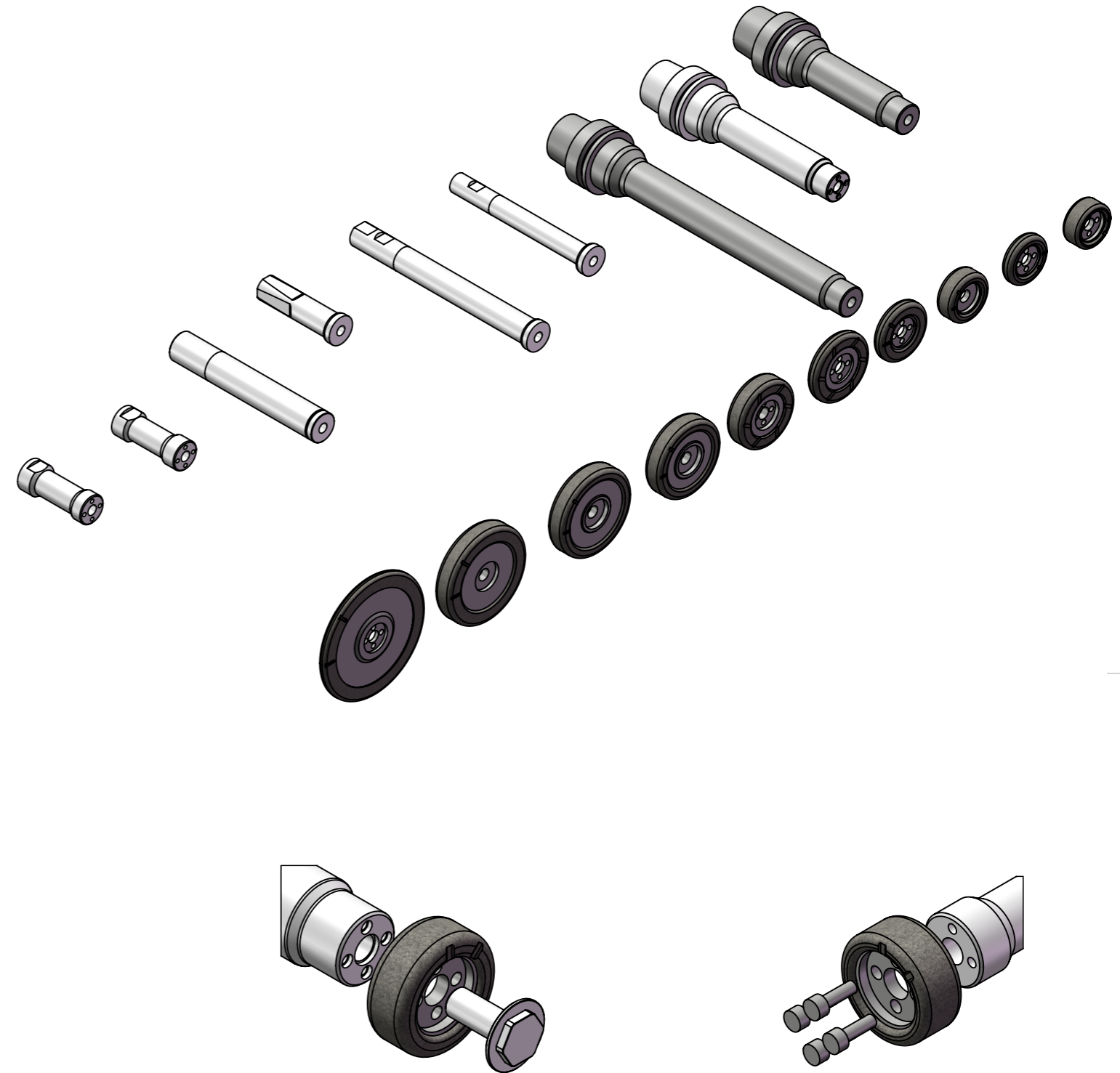

FIXING WITH LOW HEAD SPECIAL SCREW

FIXING WITH 4x M5 STANDARD SCREWS

NEW ADAPTERS CAN BE PRODUCED ACCORDING TO YOUR NEEDS



MUZZI

info@muzzisrl.it
www.muzzisrl.it

STANDARD Ø30 MUZZI FIXING - TOOL HOLDERS AND DIAMOND WHEELS

DISEGNATORE: Matteo Muzzi 102230 STATO: APPROVED REVISION 0

DISIGNATO 20/11/2021

TIPO TAVOLA

APPROVATO 22/11/2021

CATALOGUE

SHEET 1 OF 1 A3